

TS-324R-05-0300



Product image serves as example only.

TS-324R-05-0300

Omnipolar
Flatpack TMR Sensor

Block Diagram

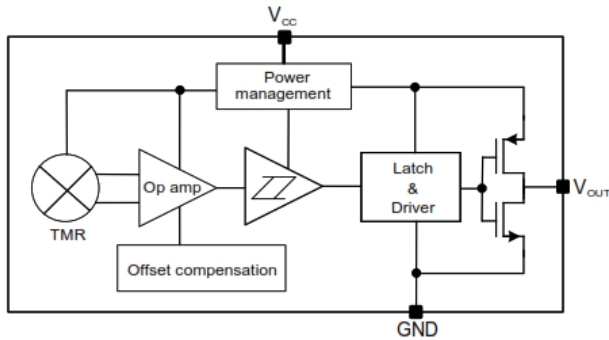

Features

- Compact size
- CMOS push-pull output
- Ultra-Low power consumption
- Excellent thermal stability
- High frequency response
- High sensitivity

Approvals



Application Information

In our products an external bypass capacitor is connected in close proximity to the device between the supply and ground pins to reduce noise. The value for the external capacitor is 0.1 µF.

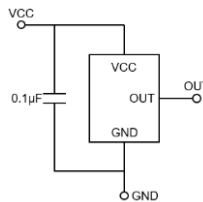

Dimensions

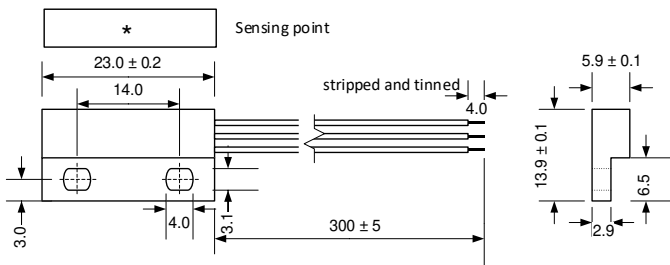

* other positions on request

Wire Assignment

Symbol	Function	Wire Colour
V _{CC}	Supply Voltage	Blue
V _{OUT}	Output	White
GND	Ground	Black

TS - 324R - 05 - 0300
Wire Length [mm]

Material Information

	Material	Colour
Housing	ABS	Black
Wire	UL1007/1569, AWG24	Blue, White, Black
Potting Compound	Epoxy	Black

Environmental Characteristics

Operating Temperature	°C	- 20 to + 85
-----------------------	----	--------------

TS-324R-05-0300

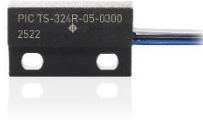

TS-324R-05-0300

Omnipolar
Flatpack TMR Sensor

Electrical Characteristics

Parameter	Symbol	Condition	Min.	Typ.	Max.	Unit
Supply voltage	VCC	operating	1,8	3	5,5	V
Output high voltage	VOH	RP status	VCC-0.3	-	VCC	V
Output low voltage	VOL	OP status	0	-	0,2	V
Supply current	ICC	output open	0,5	1,5	2	µA
Response frequency	F	-	0 to 1000			Hz
			0 to 5000 unavailable			Hz

Note: A 100 nF capacitor is connected between VCC and GND during all tests on the above table.

Absolute Maximum Ratings

Parameters	Symbol	Min.	Max.	Unit
Supply voltage	VCC	-0,3	7	V
Output current	ISINK and ISOURCE	-	9	mA
Magnetic flux density	B	-	400	mT
ESD performance (HBM)	VESD	-	4	kV

Note: I_{SINK} is the current flowing through the high side MOSFET, when the high side MOSFET is turned on and I_{SOURCE} is the current flowing through the low side MOSFET when the low side MOSFET is turned on.

Magnetic Characteristics

Parameter	Symbol	Min.	Typ.	Max.	Unit
Operate point	B ^{OPS}	0,3	0,5	0,9	mT
	B ^{OPN}	-0,9	-0,5	-0,3	mT
Release point	B ^{RPS}	0,25	0,3	0,7	mT
	B ^{RPN}	-0,7	-0,3	-0,25	mT
Hysteresis	B ^H	0,05	-	0,65	mT

TS-324R-05-0300

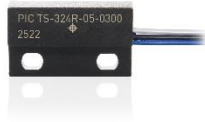

TS-324R-05-0300

Omnipolar
Flatpack TMR Sensor

Output Behavior vs. Magnetic Pole

Parameter	Test Conditions	Output
South Pole	$B > B_{OPS}$	Low (On)
	$0 < B < B_{RPS}$	High (Off)
North Pole	$B < B_{OPN}$	Low (On)
	$0 > B > B_{RPN}$	High (Off)

Note: When power is turned on under zero magnetic field, the output is "High".

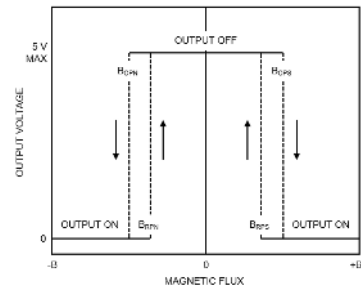

Magnetic Approach (for example) for Omnipolar Type

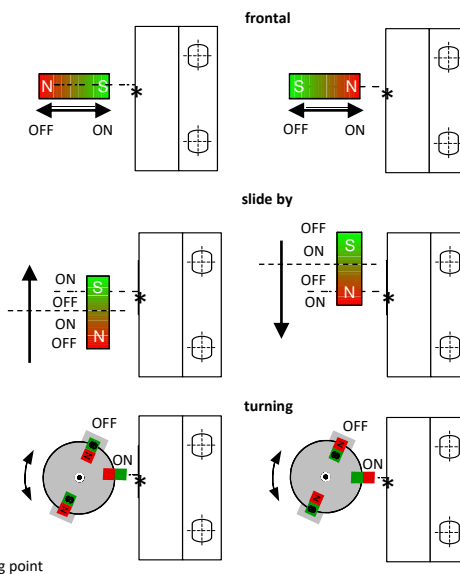

By sliding by two turn on and turn off operations possible